



**FLECK** NXT2 TIMER  
SERVICE MANUAL

Do you need help, field service or parts?

Don't Wait contact Complete Water

(855) 787-4200 [info@complete-water.com](mailto:info@complete-water.com)

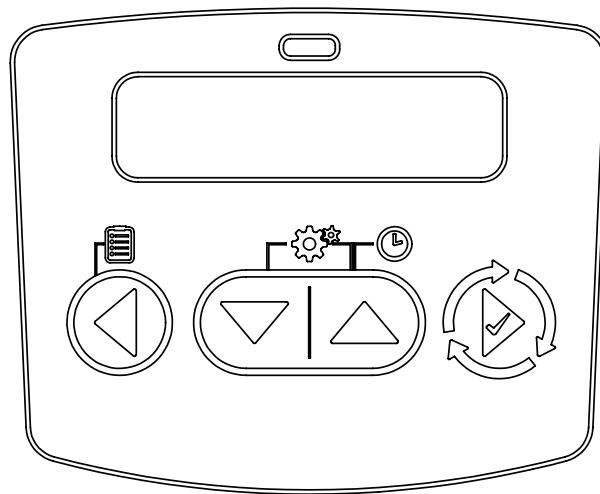

**COMPLETE  
WATER**  
SOLUTIONS



(855) 787-4200 [info@complete-water.com](mailto:info@complete-water.com)

## TABLE OF CONTENTS

OPERATING PARAMETERS .....	3
FEATURES .....	3
TIMER DISPLAY .....	4
TIMER OPERATION .....	5
TIMER FEATURES .....	6
SYSTEM DEFINITIONS .....	8
MASTER PROGRAMMING MODE FLOW CHART .....	9
USER PROGRAMMING MODE FLOW CHART .....	10
DIAGNOSTIC PROGRAMMING MODE FLOW CHART .....	11
TIME OF DAY PROGRAMMING MODE FLOW CHART .....	12
NXT2 TIMER ASSEMBLY (2510, 2750, 2850, 2900, 3150, 3900 VALVES) .....	14
NXT2 TIMER ASSEMBLY (2815 VALVE) .....	15
NXT TO NXT2 CONVERSION KITS .....	16
NXT2 WIRING DIAGRAM .....	17
POWER SUPPLY CONNECTIONS .....	18
NETWORK/COMMUNICATION CABLES AND CONNECTIONS .....	18
ERROR CODES AND TROUBLESHOOTING .....	19

## IMPORTANT PLEASE READ:

- The information, specifications and illustrations in this manual are based on the latest information available at the time of release. The manufacturer reserves the right to make changes at any time without notice.
- This manual is intended as a guide for service of the valve only. System installation requires information from a number of suppliers not known at the time of manufacture. This product should be installed by a plumbing professional.
- This unit is designed to be installed on potable water systems only.
- This product must be installed in compliance with all state and municipal plumbing and electrical codes. Permits may be required at the time of installation.
- It is established that when daytime water pressure exceeds 80 psi (5.5 bar), the maximum pressure rating of 125 psi (8.6 bar) can be exceeded. A pressure regulator must be installed on this system or warranty is voided.
- Do not install the unit where temperatures may drop below 32°F (0°C) or above 120°F (52°C).
- Do not place the unit in direct sunlight. Black units will absorb radiant heat, increasing internal temperatures.
- Do not strike the valve or any of the components.
- Warranty of this product extends to manufacturing defects. Misapplication of this product may result in failure to properly condition water, damage to product, or personal injury.
- A prefilter should be used on installations in which free solids are present.
- In some applications local municipalities treat water with Chloramines. High Chloramine levels may damage valve components.
- Correct and constant voltage must be supplied to the controller to maintain proper function.
- The system is intended to treat only potable quality water. It is not intended as the permanent primary treatment of water from a source that is contaminated, such as from radon, pesticides, insecticides, sewage or wastewater.
- This system is not intended for use by persons (including children) with reduced physical, sensory, or mental capabilities, or lack of experience and knowledge, unless they have been given supervision or instruction concerning use of the appliance by a person responsible for their safety.
- Children shall not play with the system.
- Cleaning shall not be made by children without supervision.
- Periodic cleaning and maintenance may be required to function properly.
- All plumbing and electrical should be done in accordance with local codes.
- An uninterrupted power supply is required. The control uses a transformer to supply 24 VDC. Please make sure your voltage supply is compatible with your unit before installation.

## CALIFORNIA PROPOSITION 65 WARNING

**⚠ WARNING:** This product contains chemicals known to the State of California to cause cancer or birth defects or other reproductive harm.

## OPERATING PARAMETERS

Minimum Pressure	20 psi/1.4 bar/138 kPa
Maximum Pressure	125 psi/8.61 bar/861 kPa
Minimum Water Temperature	34°F/1°C
Maximum Water Temperature	110°F/43°C
Minimum Ambient Temperature	34°F/1°C
Maximum Ambient Temperature	120°F/52°C
Maximum Humidity	75%
Input Voltage	100-240 VAC
Input Frequency	50/60 Hz
Output Voltage	24 VDC
Output Current	2.7 amps
Maximum Altitude	2,000 meters
System Type	4 - Single Unit 5 - Parallel Interlock (2-8 Unit) 6 - Parallel Series Regeneration (2-8 Units) 7 - Alternating Interlock (2 Units) 8 - Alternating Delayed (2 Units) 9 - Alternating with Standby Units (2-8 Units) 14 - Demand Recall (2-8 Units)
Valve Type	2510 2750 2815 2850 2900 3150 3900
Regeneration Type	Softener/Filter Meter Delayed Softener/Filter Meter Immediate Time Clock Day of the Week Remote Regeneration
Regeneration Flow	Downflow Upflow Filter
Electrical Rating	24V DC

## FEATURES

- On-screen multilingual support: English, Francais, Deutsch, Italiano, Espanol, Nederlands, Portugues
- Time of day super capacitor backup for 12-hour power loss
- 2 to 4 line scrolling text OLED display, high contrast easy to read in low light conditions and at a distance
- Full functional user interface with easy programming allowing forward and backwards menu navigation
- Network two to eight valves via CAT5 or better cables
- LED Status Indicator
  - Blue: In Service
  - Flashing Blue: Regeneration Queued
  - Green: Regeneration
  - Flashing Green: Standby
  - Red: Error condition present
- Two Programmable Auxiliary relay outputs
  - Time-based
  - Volume based (Chemical pump)
  - Alarm-based
  - Cycle-based
  - Standby
- Remote input
  - Remote Lockout
  - Remote Regeneration
- Easy installation with plug-in wiring harnesses
- Assistance Name and Phone Number contact fields
- Error Log History
- Water Usage Daily (up to 13 weeks)
- Push Settings
- Capacitive Touch buttons
- Two Regeneration Lockout Windows
- Reset to factory default settings or from saveable custom settings
- Full calendar display
- Master Programming Lockout
  - Code-based
  - Time-based
  - Delayed
- Icons for easy system status identification
- Dynamic network addressing
- Diagnostics
  - Real-time Flow Rate
  - Peak Flow Rate (can be reset)
  - Totalizer (can be reset)
  - Reserve Capacity
  - Use Since Last Regeneration
  - Last Regeneration
  - Identifiable Software Version
  - Total Number of Regenerations
  - Regeneration Interval
  - Last Settings Change
  - Error Log History
  - Average Daily Usage (per weekday, 3 month history)

# TIMER DISPLAY

System Number    Network Indicator    Valve State    Flow Indicator    Status LEDs    Master Indicator    Time of Day

**Blue LED**  
On - Unit in Service  
Blinking - Regeneration Queued

**Green LED**  
On - Unit in Regeneration  
Blinking - Unit in Standby

**Red LED**  
On - Error present

**Display Screen**  
Alternates between Date, Flow Rate, and Volume Remaining (If a regeneration is queued, displays time until regeneration)

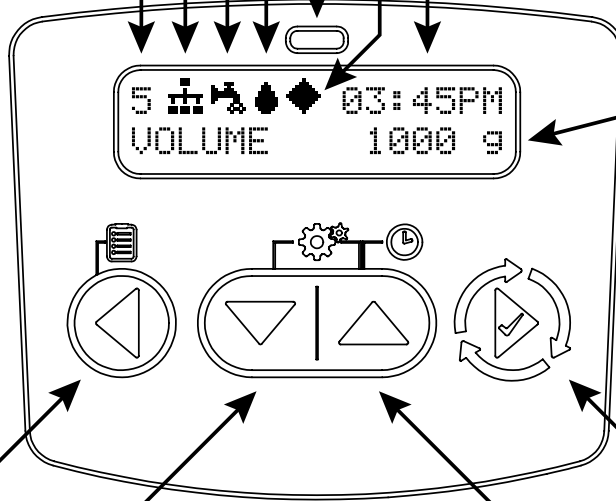

**Left Button**  
Press:  
Navigate to previous menu option  
  
Press and Hold:   
Enter Diagnostic menu

**Down Button**  
Press:  
Adjust menu value down  
  
Press and Hold:   
Enter Time of Day menu





















**Up Button**  
Press:  
Adjust menu value up  
  
Press and Hold:   
Enter Time of Day menu

**Extra Cycle Button**  
Press:  
Navigate to next menu option  
  
Press and Hold:  
Initiate a regeneration

**Left Button + Down Button**  
Press and Hold -  
Enter Master Programming

 **Down Button + Up Button**  
Press and Hold -  
Enter User Programming

## Display Icons

- |  |                                  |   |                         |
|--|----------------------------------|---|-------------------------|
|  | Valve State: Service             |  | Lock Window             |
|  | Valve State: Standby             |  | Initializing            |
|  | Flow Indicator (flashing)        |  | Upper Drive Movement    |
|  | Regeneration                     |  | Lower Drive Movement    |
|  | Master Unit (auto-assigned)      |  | Remote Regeneration     |
|  | Network Indicator - Connected    |  | Master Programming      |
|  | Network Indicator - Disconnected |  | User Programming        |
|  | Network Indicator - Unit Missing |  | Diagnostics             |
|  | USB Connected (Field Programmer) |  | Time of Day Programming |
|  | Error Condition Present          |   |                         |
|  | Remote Lock                      |   |                         |

## TIMER OPERATION

### Setting the Time of Day

**NOTE: Set Time of Day on any unit and the rest of the units in the system will update the Time of Day automatically.**

1. Press and hold the Up button for 2 seconds. The "Time" value is displayed. Press the Up or Down buttons to adjust as desired.
2. Press the Extra Cycle button to advance to the "Year" field. Press the Up or Down buttons to adjust as desired.
3. Press the Extra Cycle button to advance to the "Month" field. Press the Up or Down buttons to adjust as desired.
4. Press the Extra Cycle button to advance to the "Calendar Day" field. Press the Up or Down buttons to adjust as desired.
5. Press the Extra Cycle button to return to the normal display screen.

**NOTE: Press and hold the Left button to exit without saving.**

### Manually Initiating a Regeneration

1. When timer is In Service or Standby, press and hold the Extra Cycle button on the main screen.
2. The timer advances to Regeneration Cycle Step #1, and begins programmed time count down.
3. Press the Extra Cycle button once to advance valve to Regeneration Cycle Step #2 (if active).
4. Press the Extra Cycle button once to advance valve to Regeneration Cycle Step #3 (if active).
5. Press the Extra Cycle button once to advance valve to Regeneration Cycle Step #4 (if active).
6. Press the Extra Cycle button once to advance valve to Regeneration Cycle Step #5 (if active).
7. Press the Extra Cycle button once more to advance the valve back to In Service.

**NOTE: A manually initiated or queued regeneration can be cleared by pressing and holding the Back button. A system queued regeneration can only be cleared by stepping through a manual regeneration. If regeneration occurs for any reason prior to the delayed regeneration time, the manual regeneration request shall be cleared. Pressing the Extra Cycle button while in regeneration will cause the upper drive to advance to the next step immediately.**

### Timer Operation During Regeneration

In the Regeneration Cycle step display, the timer shows the current regeneration cycle name the valve is in, or has reached, and the time remaining in that step. Once all regeneration steps are complete, the timer returns to In Service and resumes normal operation.

CYCLE 1/5	
BACKWASH	00:10:00

CYCLE 2/5	
DRAW	00:60:00

CYCLE 3/5	
RAPID RINSE	00:10:00

CYCLE 4/5	
TANK REFILL	00:12:00



Press the Extra Cycle button during a system queued Regeneration Cycle to immediately advance the valve to the next cycle step position and resume normal step timing.

### Timer Operation During Programming

The timer enters the Program Mode in Standby or Service Mode as long as it is not in regeneration. While in the Program Mode, the timer continues to operate normally monitoring water usage. Timer programming is stored in memory permanently.

### Timer Operation During A Power Failure

All program settings are stored in permanent memory. Current valve position, cycle step time elapsed, and time of day are all stored during a power failure, and will be restored when power is re-applied. Time is kept during a power failure, and time of day is adjusted upon power up (as long as power is restored within 12 hours).

**NOTE: The time of day on the main display screen will flash for 5 minutes when there has been a power outage. The flashing of the time of day can be stopped by pressing any button on the display.**

### Flow Meter Equipped Timer

As treated water is used, the Volume Remaining display counts down from the calculated system capacity to zero. When zero is reached, a Regeneration Cycle begins if no other units are in regeneration.

## TIMER FEATURES

### Remote Lock

The timer does not allow the unit/system to go into Regeneration until the Regeneration Lockout Input signal to the unit is cleared. This requires a contact closure to activate the unit. The recommended gauge wire is 16 AWG with a maximum wire length run of 50 feet.

### Regeneration Day Override Feature

If the Day Override option is turned on and the valve reaches the set Regeneration Day Override value, the Regeneration Cycle starts if no other unit is in Regeneration. If other units are in regeneration, it is added to a regeneration queue. This occurs regardless of the remaining volume available.

### Lock Settings (access to Master Programming)

Lock Settings prevents the user from accessing Master Programming. In Master Programming, select the desired Lock Settings option (Off, Time Based, Delayed, or Enter Code).

**Time Based** - User must set clock to 12:01 pm to unlock

**Delayed** - User must press and hold the Left and Down buttons for 60 continuous seconds to unlock

**Enter Code** - User must input code "1201" to unlock

### Capacitive Buttons

Capacitive button entry warrant different consideration than tactile button entry. Do not wear gloves. Be sure to keep your hands and the capacitive buttons free of debris, grease, or water. Buttons may become temporarily unresponsive if environmental conditions change such as sudden humidity or temperature changes. If buttons become unresponsive, wait 5 to 10 minutes for the buttons to recalibrate.

### LED Status indicator

Blue - Unit in Service  
Flashing Blue - Regeneration Queued  
Green - Regeneration  
Flashing Green - Standby  
Red - Error with codes

### Power Loss Backup

Time of day super capacitor backup for power loss; rated to last minimum 12 hours

### Continuous Flow Detect

Alert appears when specified continuous flow rate is detected during service over a specified duration. Continuous flow rate is adjustable from 0.1 to 999.9 GPM/LPM (accuracy of flow rate detected will vary based on capability of meter). Duration range is adjustable from 1 to 255 hours.

### Remote Regeneration

Ability to trigger a regeneration via a remote input.

### Regeneration Types

**Softener/Filter Meter Delayed** - When volume remaining reaches zero and the scheduled regeneration time is reached (default 2 a.m. softener; 12 a.m. filter), the unit will regenerate.

**Softener/Filter Meter Immediate** - When volume remaining reaches zero, the unit will regenerate.

**Time Clock** - Once volume remaining reached zero and the selected regeneration time is reached (default 2 a.m. softener; 12 a.m. filter), the unit will regenerate.

**Day of the Week** - Once volume remaining reaches zero and the selected Day of the Week is reached, the unit will regenerate.

**Remote Regeneration** - Regeneration begins or is queued after a contact closure meets or exceeds for the length of time specified in the Remote Signal Duration (Range 1-30 seconds Service; 60-300 seconds Standby). Unit regenerates will occur based on the Remote Regeneration specified method (Immediate or Delayed). Immediate Regeneration will immediately initiate a regeneration. Delayed Regeneration will initiate a regeneration based on the programmed regeneration time selected.

### Reset to Factory Defaults

While powering up the unit, when the Pentair logo appears, press and hold the Extra Cycle button to access the Reset menu then select Reset to Factory Defaults. Press the Extra Cycle Button to confirm your selection and to advance to the service screen. Furthermore, you may select Reset to Non-Factory Defaults to save a set of unique control parameters.



Power on the unit.  
When Pentair logo appears,  
press and hold the Extra Cycle button.  
The Reset menu appears.

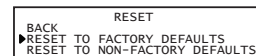

Use the up/down buttons to select.



Press the Extra Cycle button to set the  
desired option and return to the  
Service screen.

END

### Lock Window

Lock Window prevents the unit from regenerating during a specified time frame. Two lock windows are available (Lock Window #1 and Lock Window #2). In Master Programming, enable a Lock Window then select the desired Lock Start time and Lock End time.

### Settings Review

To prevent unintentional changes to Master Programming, enable Settings Review to view and navigate through Master Programming settings without the ability to edit.

# TIMER FEATURES *continued...*

---

## Push Settings

The ability to transmit settings from one unit to all other connected units. Select the desired Master Programming settings on one unit then push the same settings to all other connected units. After push settings are complete, you may still make unique changes to individual units.

## Auxiliary Relays

The NXT2 has two auxiliary relays available based on cycle, time, or volume.

AUX.1: CYCLE BASED						
SP	BW	BD	RR	RF	SB	
X	X	✓	X	X	X	

Activates during selected cycle step

AUX.1:TIME BASED-START TIME #1
1 M

Activates upon selected start time  
(Range: 0-91 minutes)

AUX.1:TIME BASED-END TIME #1
5 M

Deactivates upon selected end time  
(Range: Start Time plus 1 minute)

AUX.1:VOLUME BASED - VOLUME-G
00100

Activates when selected volume (gallon)  
is reached (Range: 0-99999)

AUX.1:VOLUME BASED - DURATION-S
0010

Selected Duration in Seconds  
(Range: 0-9999 seconds)

## SYSTEM DEFINITIONS

---

### System 4 - Single Unit

Single Tank configuration  
Time Clock: No Meter  
Immediate: One Meter  
Delayed: One Meter  
Remote Signal Start

### System 5 (2-8 Units) Parallel Interlock)

All tanks in parallel supplying treated water. Each unit in the system will have its own flow meter/sensor input. The control will delay the start of Regeneration if another unit is already in Regeneration. Once that unit has completed a Regeneration cycle, and has returned to Service, the unit with the longest regeneration queue time will begin Regeneration. No more than one unit will be in Regeneration at a time.

### System 6 (2-8 Units) Parallel Series Regeneration

All tanks in parallel supplying treated water. Only #1 control will monitor flow meter/sensor input. When a regeneration is required for the system, it will regenerate valve address #1 first, immediately followed by #2, then #3, then #4 if installed. No more than one unit will be in Regeneration at a time.

### System 7 (2 Units) Alternating Immediate

One tank online supplying treated water, one tank in Standby. Only #1 control will monitor its flow meter/sensor input. Regeneration of a unit will begin after the other control has left Standby and returned to Service. When the Regeneration cycle is complete, the regenerated unit will enter Standby. Standby on each tank is controlled by the relay on the NXT2 circuit board.

### System 8 (2 Units) Alternating Delayed

Immediate Transfer Delayed Regeneration  
One tank online supplying treated water, one tank in Standby. Only #1 control will monitor its flow meter/sensor input. Online unit depletes its volume. Once this occurs the offline unit comes online. The previously online unit goes offline and delays its regeneration until the programmed regeneration time has been reached.

### System 9 (2-8 Units) Alternating with Standby Units

Up to 7 tanks online supplying treated water, one tank in Standby. Meter/sensor input is required on each tank. Regeneration of a unit will begin after the other control has left Standby and returned to Service. When the Regeneration cycle is complete, the regenerated unit will enter Standby. Standby on each tank is controlled by the relay on the NXT2 circuit board.

### System 14 (2-8 Units) Demand Recall

Meter input is required on each tank. Unit #1 will begin In Service with #2, #3, and #4 (if installed) will begin in Standby. At least one unit is In Service at all times. When flow rate to the Primary Service Unit increases to a user specified rate, the next unit in sequence will move from Standby to Service. As the flow rate falls below the user specified rate, subsequent tanks will return to Standby. When the Primary Service Unit regenerates, the next unit in sequence will become the new Primary Service Unit. As each unit's capacity is reached, the controller will initiate a Regeneration of that unit. Depending on the number of units in the system and flow rate demand, the regenerated unit will then be placed either into Standby or Service. Only one unit will be in Regeneration at a time.



# MASTER PROGRAMMING MODE FLOW CHART

**CAUTION** Before entering Master Programming, please contact your local professional water dealer.

**NOTE:** Depending on current option settings, some values cannot be viewed or set.

## Master Programming Mode

1. Press and hold the Left and Down buttons simultaneously for 3 seconds to enter Master Programming mode.
2. To navigate, press the Extra Cycle button to advance to the next value. Press the Left button to retreat to the previous value.
3. Where applicable, use the Down and Up buttons to adjust a value as desired. When entering data into text fields (such as Assistance Name) or numerical fields (such as Hardness), press the Extra Cycle button to advance to the next character/digit and press the Left button to retreat to the previous character/digit. Proceed through all available characters/digits to advance to the next value.
4. To reset/clear a value (such as Assistance Name), while on the value, press and hold the Down and Up buttons simultaneously for 5 seconds.
5. To exit master programming mode, progress through all available values or after 5 minutes of inactivity the timer will exit automatically. To exit master programming without saving changes, press the Left button until you return to the service screen.
6. Depending on the current controller programming, certain values may not be able to be viewed or set.
7. The timer will display local information, not system information.
8. In the event of a regeneration occurring while displaying master programming, the regeneration step and time remaining will be displayed. When regeneration has been completed, the display will return to the main screen.

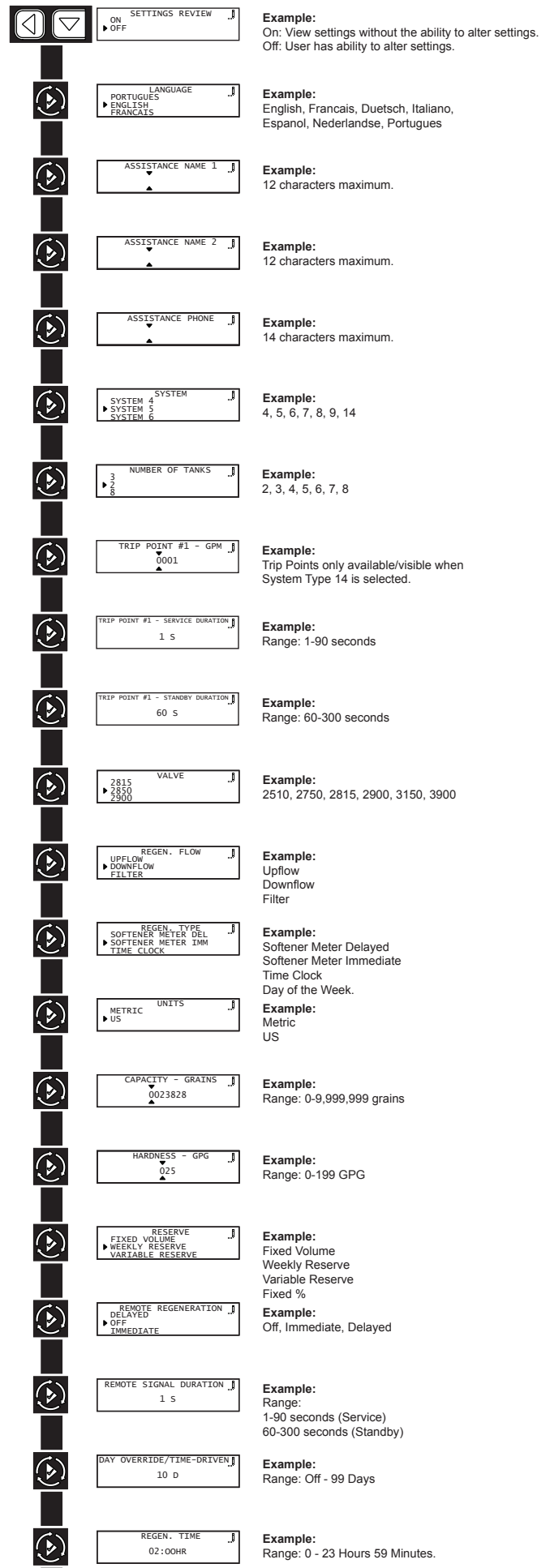

# MASTER PROGRAMMING MODE

## FLOW CHART *continued...*

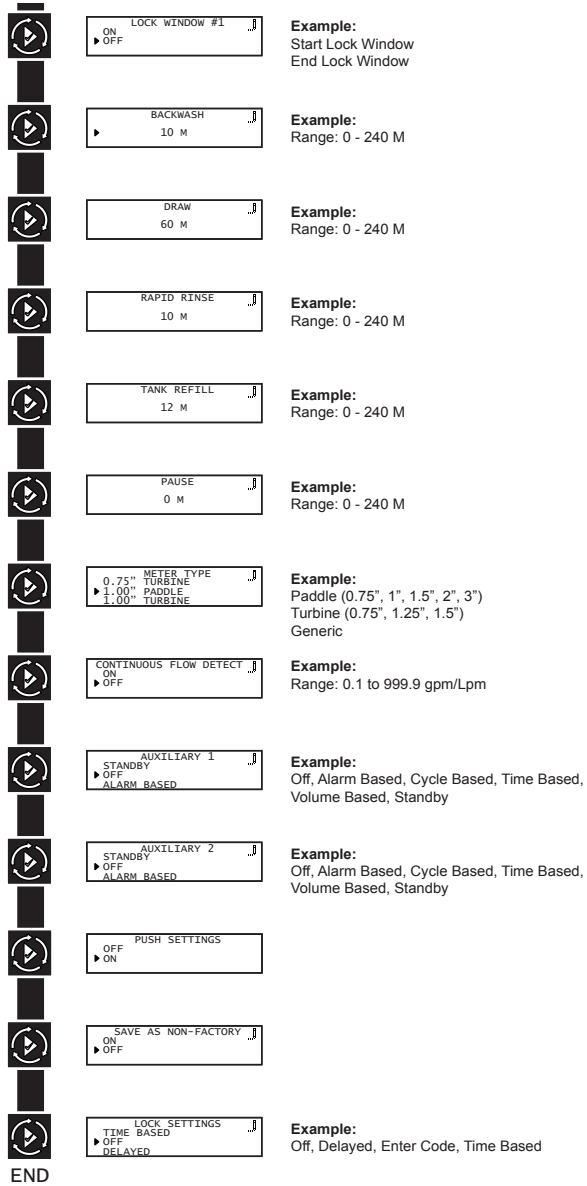

# USER PROGRAMMING MODE

## FLOW CHART

### User Programming Mode

1. Press and hold the Down and Up buttons simultaneously for 3 seconds to enter User Programming mode.
2. To navigate, press the Extra Cycle button to advance to the next value. Press the Left button to retreat to the previous value.
3. Where applicable, use the Up and Down buttons to adjust a value as desired.
4. After progressing through all available values, the timer will return to Normal operation.
5. To exit diagnostic mode, progress through all available values, press and hold the Left button at anytime, or after 5 minutes of inactivity the timer will return to normal operation automatically.
6. Depending on the current controller programming, certain values may not be able to be viewed or set.
7. The timer will display local information, not system information.
8. In the event of a regeneration occurring while displaying user programming, the regeneration step and time remaining will be displayed. When regeneration has been completed, the display will return to the main screen.

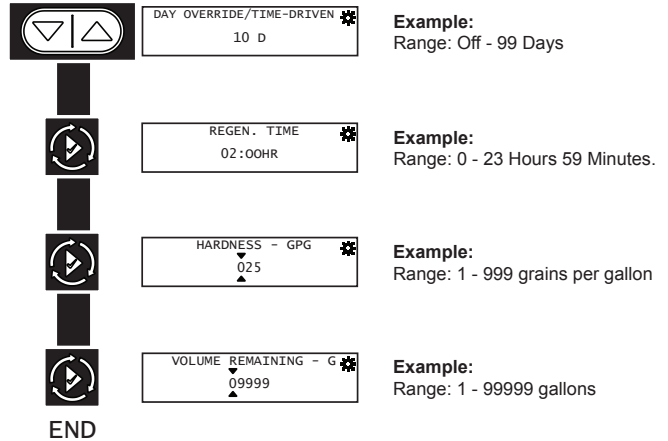

# DIAGNOSTIC PROGRAMMING MODE FLOW CHART

## Diagnostic Programming Mode

1. Press and hold the Left button to enter Diagnostic Programming mode.
2. To navigate, press the Extra Cycle button to advance to the next value. Press the Left button to retreat to the previous value.
3. Where applicable, use the Up and Down buttons to adjust a value as desired.
4. To reset/clear a value (such as Totalizer or Error Log), while on the value, press and hold the Up and Down buttons simultaneously.
5. After progressing through all available values, the timer will return to Normal operation.
6. To exit diagnostic mode, press and hold the Left button at anytime or after 5 minutes of inactivity the timer will return to normal operation automatically.
7. Depending on the current controller programming, certain values may not be able to be viewed or set.
8. The timer will display local information, not system information.
9. In the event of a regeneration occurring while displaying diagnostics, the regeneration step and time remaining will be displayed. When regeneration has been completed, the display will return to the main screen.

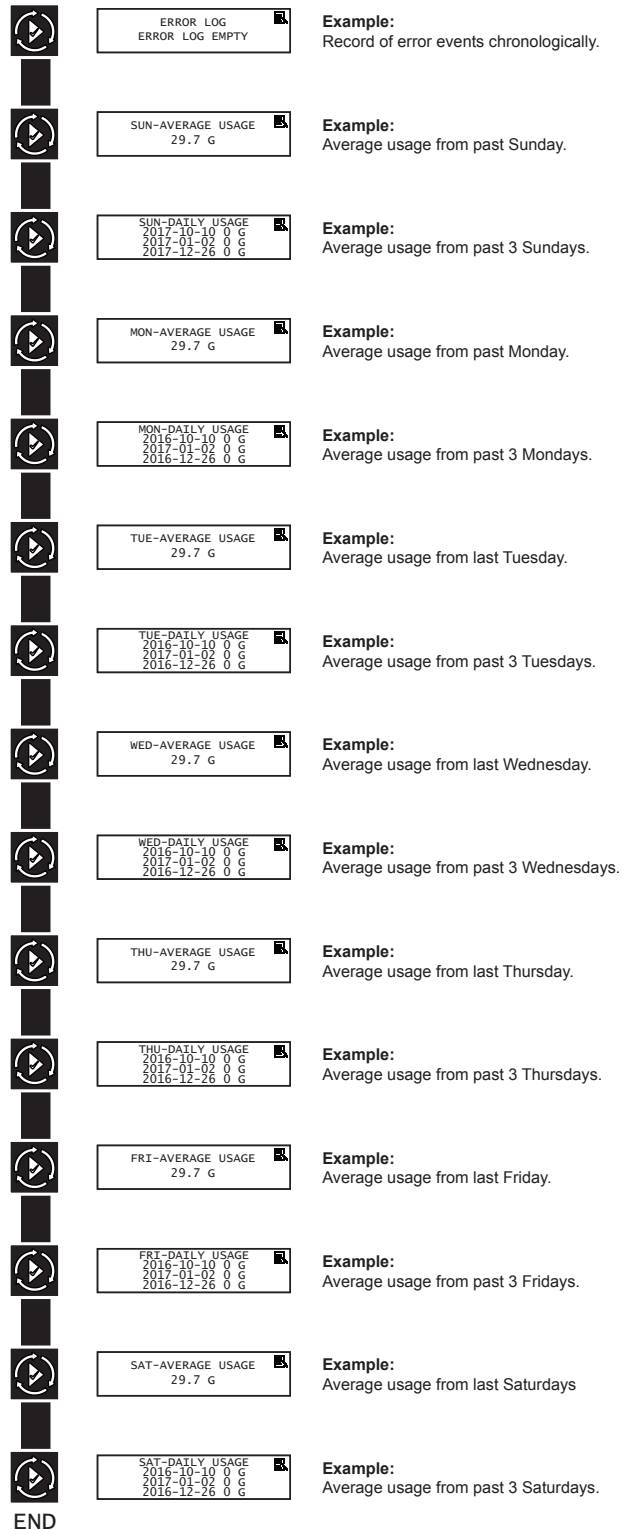
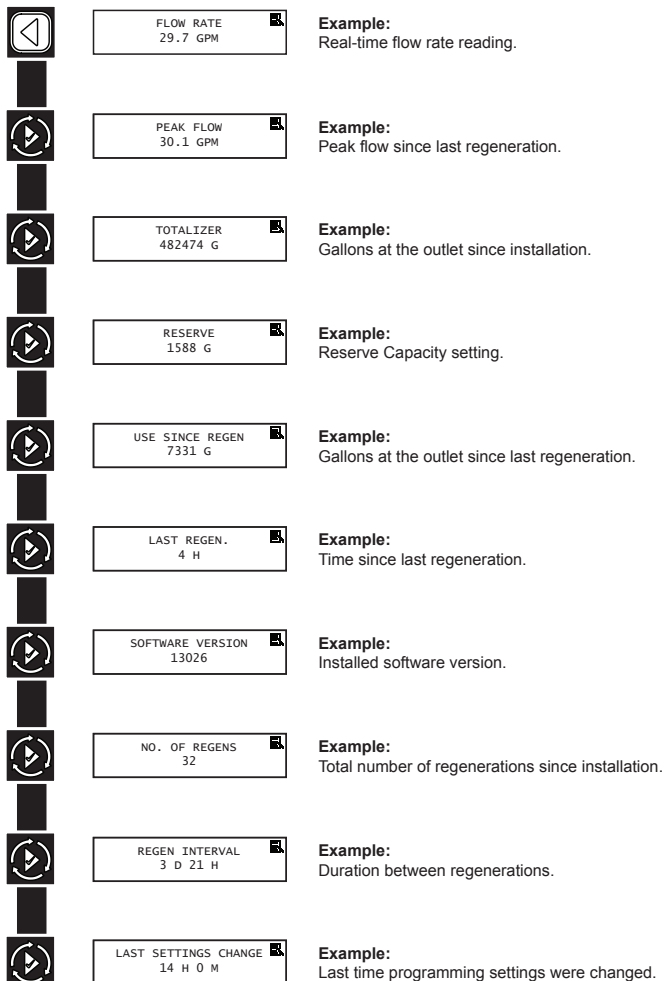

# TIME OF DAY PROGRAMMING MODE

## FLOW CHART

---

### Setting the Time of Day

**NOTE: Set Time of Day on any unit and the rest of the units in the system will update the Time of Day automatically.**

1. Press and hold the Up button for 2 seconds.  
The "Time" value is displayed. Press the Up or Down buttons to adjust as desired.
2. Press the Extra Cycle button to advance to the "Year" field.  
Press the Up or Down buttons to adjust as desired.
3. Press the Extra Cycle button to advance to the "Month" field.  
Press the Up or Down buttons to adjust as desired.
4. Press the Extra Cycle button to advance to the "Calendar Day" field.  
Press the Up or Down buttons to adjust as desired.
5. Press the Extra Cycle button to return to the normal display screen.

**NOTE: Press and hold the Left button to exit without saving.**

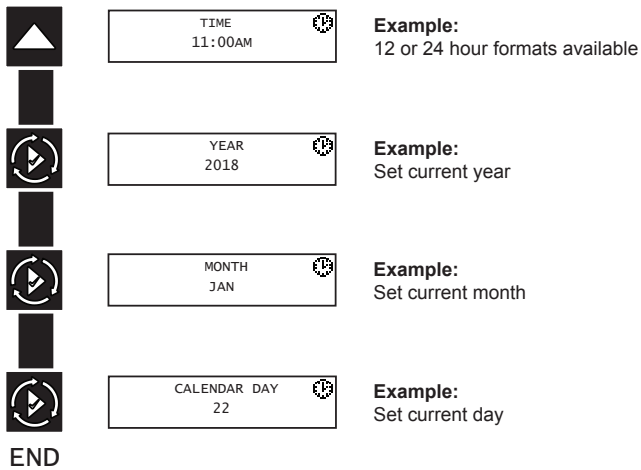

### NXT2 Programming Parameters and Ranges

System Type	4				5	6	7	8	9	14	Programming Parameter Ranges	
	Time Clock	Day of the Week	Softener/Filter Metered Immediate	Softener/Filter Metered Delayed							Interlock	Series
Settings Review	x	x	x	x	x	x	x	x	x	x		On, Off
Language	x	x	x	x	x	x	x	x	x	x		English Francais Deutsch Italiano Español Nederlands Portugues Custom
Assistance Name 1, 2	x	x	x	x	x	x	x	x	x	x		Time Clock
Assistance Phone	x	x	x	x	x	x	x	x	x	x		Day of the Week
Regen Type	x	x	x	x	x	x	x	x	x	x		Softener/Filter Metered Immediate
Valve	x	x	x	x	x	x	x	x	x	x		Softener/Filter Metered Delayed
Regen Flow	x	x	x	x	x	x	x	x	x	x		2510 2750 2815 2850 2900 3150 3900
Units	x	x	x	x	x	x	x	x	x	x		Uplow, Downflow, Filter
Remote Regeneration	x	x	x	x	x	x	x	x	x	x		US, Metric
Auxiliary 1, 2	x	x	x	x	x	x	x	x	x	x		Off, Immediate, Delayed
Lock Window 1, 2	x	x	x	x	x	x	x	x	x	x		Off, Alarm Based, Cycle Based, Time Based, On, Off
Meter Type	x	x	x	x	x	x	x	x	x	x		Paddle (0.75", 1", 1.5", 2", 3") Turbine (0.75", 1.25", 1.5") Generic
Continuous Flow Detect	x	x	x	x	x	x	x	x	x	x		On, Off
Save as Non Factory	x	x	x	x	x	x	x	x	x	x		On, Off
Lock Settings	x	x	x	x	x	x	x	x	x	x		Off, Delayed, Enter Code, Time Based
Day Override/Time Driven	x	x	x	x	x	x	x	x	x	x		Off-99 Days
Regen Time	x	x	x	x	x	x	x	x	x	x		Any
Day of the Week	x	x	x	x	x	x	x	x	x	x		SU, MO, TU, WE, TH, FR, SA
Capacity			x		x		x		x			0-9,999,999 Grains 0-9,999,999 Grams, 0-560,287 Lx°DH, 0-1,000,000 Lx°FTH, 0-701,557 Lx°EH
Hardness			x		x		x		x			0-199,999 GPG 0-199,999 mg/L, 0-1,402 °EH, 0-199,9 °FTH, 0-112 °DH
International Hardness Units			x		x		x		x			mg/L, °EH, °FTH, °DH
Reserve					x							Weekly Reserve, Variable Reserve, Fixed %, Fixed Volume
Number of Tanks (Max)	1	1	1	1	8	8	2	2	8	8		2, 3, 4, 5, 6, 7, 8
Push Settings					x		x		x			On, Off
Trip Point #1-7 GPM												0-7,569 LPM
Trip Point #1-7 SD												1-90s
Trip Point #1-7 STBD												60-300s

**NXT2 TIMER ASSEMBLY**  
**(2510, 2750, 2850, 2900, 3150, 3900 VALVES)**

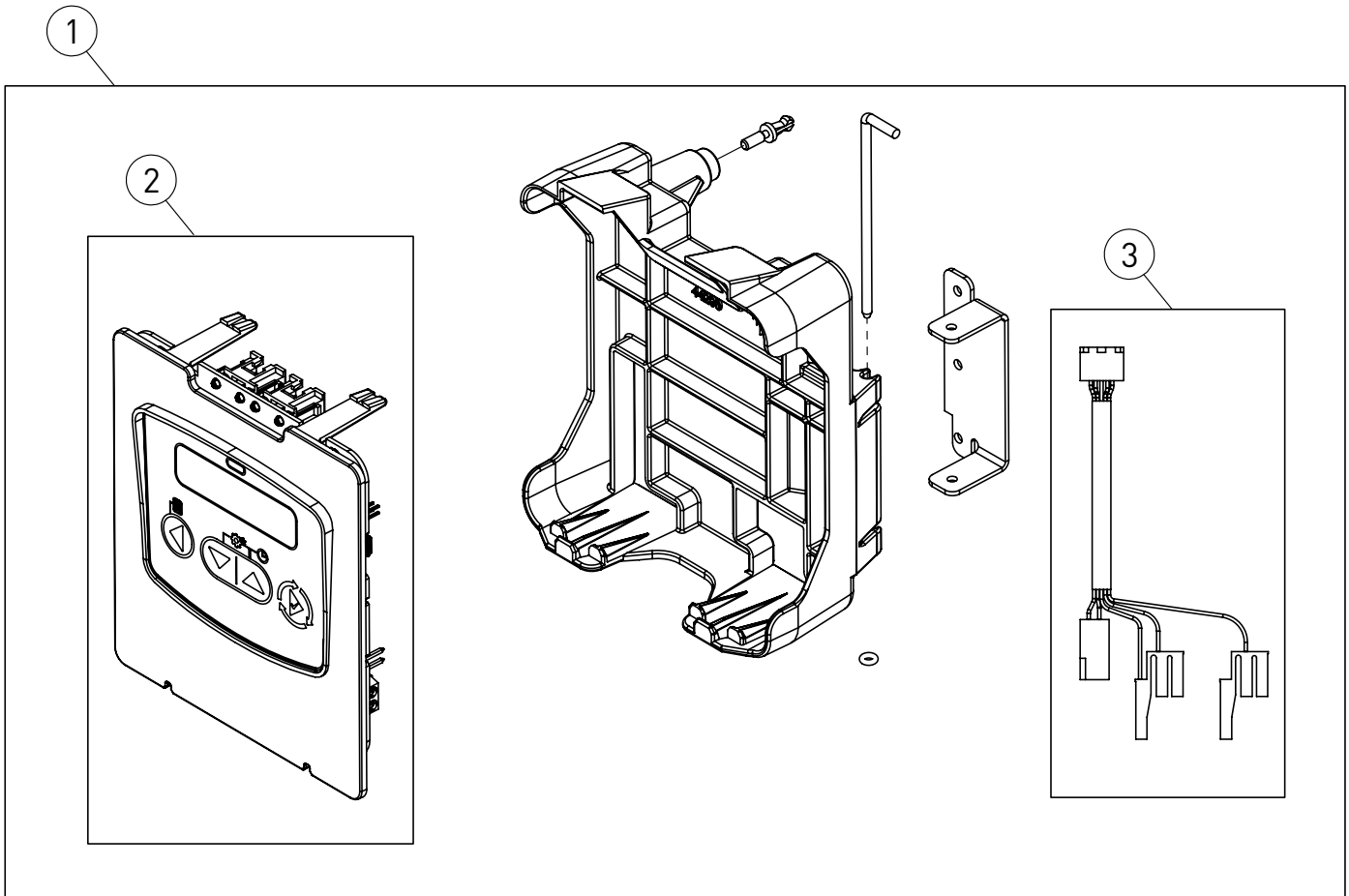

62115 Rev A

Item No.	QTY	Part No.	Description
1.....	1.....	62115 .....	Timer Assy, NXT2

**Service Assemblies**

2.....	1.....	62120 .....	Control Panel Assy, NXT2, Programmed
3.....	1.....	40941 .....	Wire Harness, Upper Drive

# NXT2 TIMER ASSEMBLY (2815 VALVE)

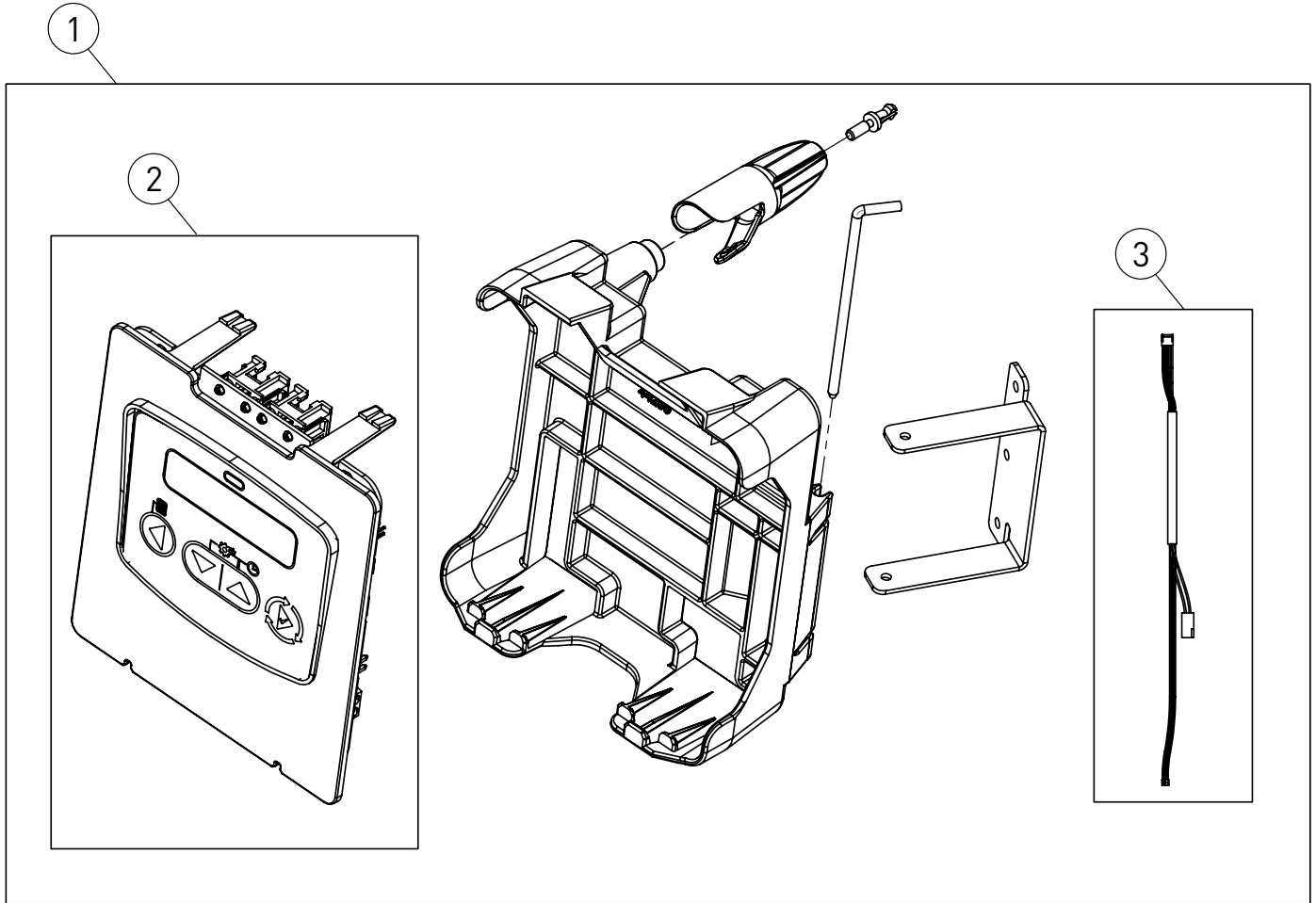

62115-01 Rev A

Item No.	QTY	Part No.	Description
1.....	1.....	62115-01.....	Timer Assy, NXT2, 2815

### Service Assemblies

2.....	1.....	62120.....	Control Panel Assy, NXT2, Programmed
3.....	1.....	44076.....	Wire Harness, Upper Drive

## NXT TO NXT2 CONVERSION KITS

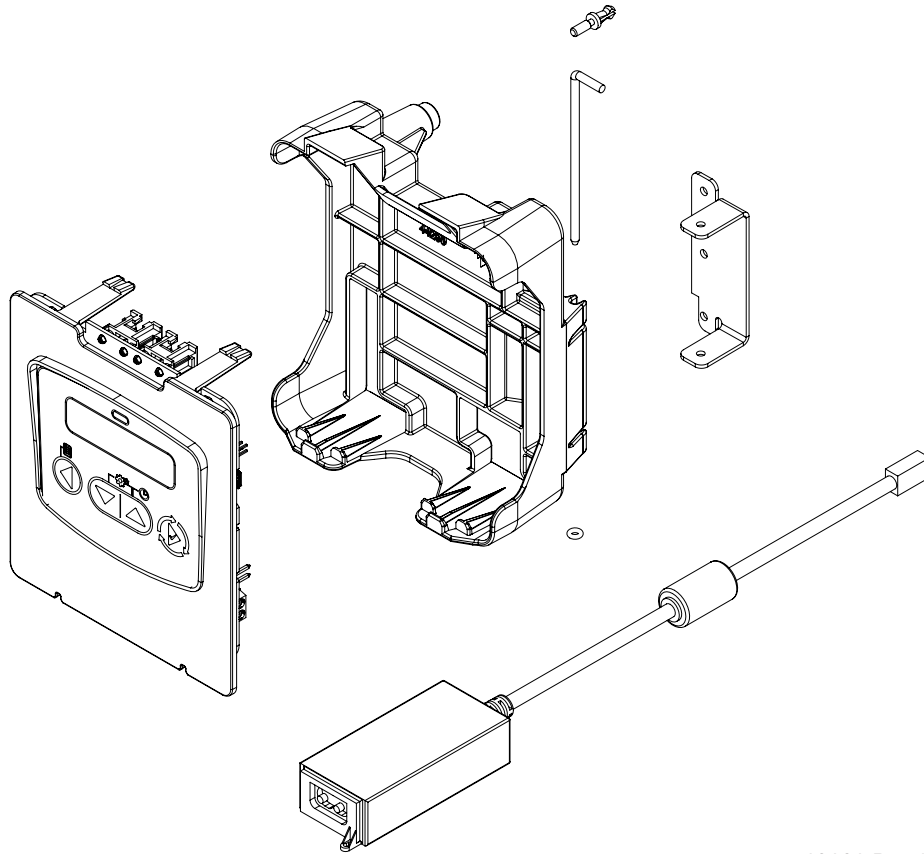

62121 Rev A

Item No.	QTY	Part No.	Description
	1	62121-01	Conversion Kit, NXT2, US
	1	62121-02	Conversion Kit, NXT2, Euro
	1	62121-03	Conversion Kit, NXT2, Aust
	1	62121-04	Conversion Kit, NXT2, Japan

**NOTE: Conversion Kits do not include wiring harness; save and reuse existing NXT wiring harness. Region-specific power supply is included.**



# NXT2 WIRING DIAGRAM

IRING DIAGRAMS ARE REFERENCE ONLY. ALL WIRING SHOULD BE DONE BY A CERTIFIED ELECTRICIAN AND MEET ALL ELECTRICAL CODES.

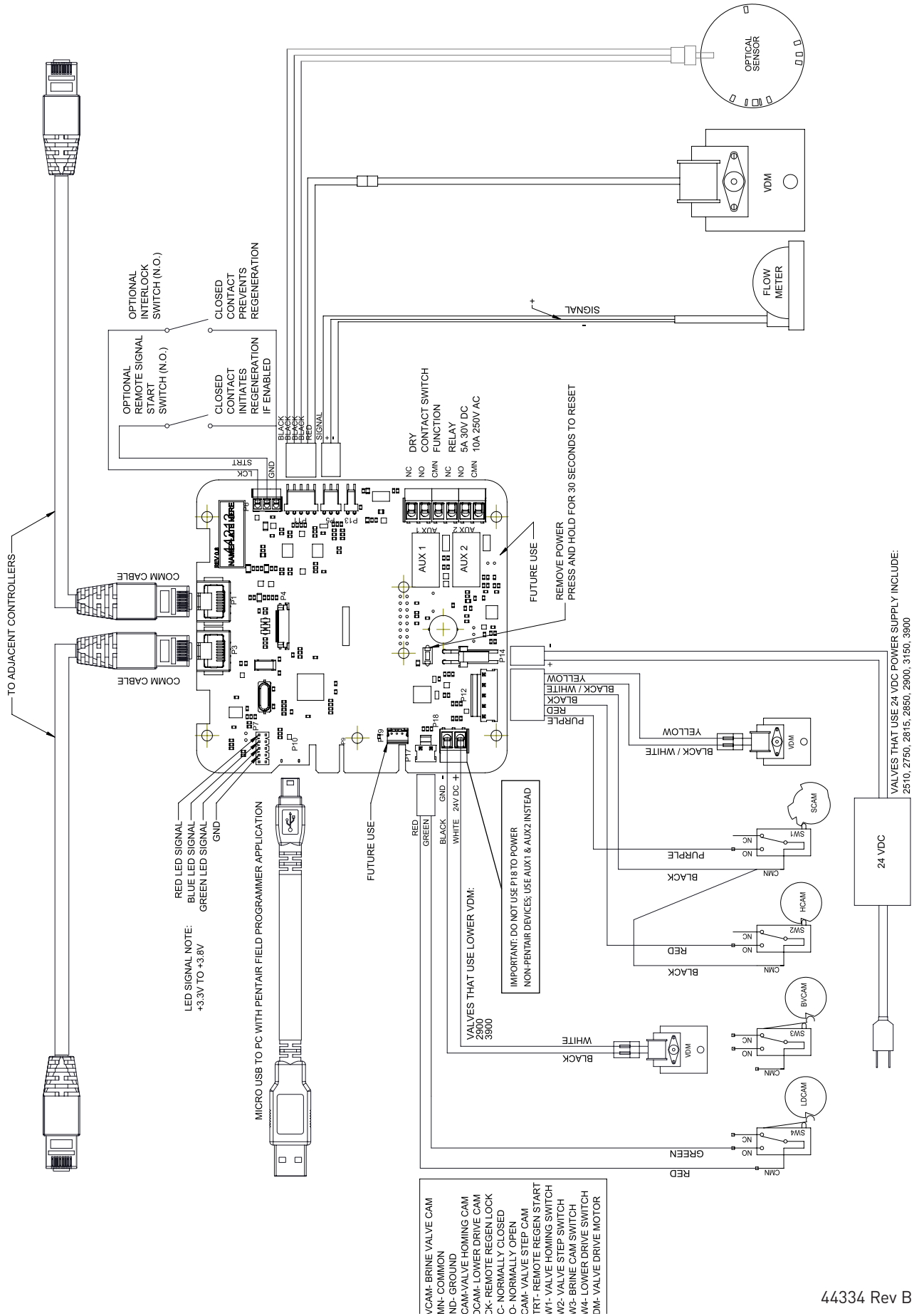

## POWER SUPPLY CONNECTIONS

### Installing the Power Supply:

**NOTE:** Power Supply includes a harness with 2 black wires that connect to circuit board, see page 15.

1. Insert black and black transformer wires into 24VDC input of control.

## NETWORK/COMMUNICATION CABLES AND CONNECTIONS

Use a CAT5 or better Network/Communication cable.

Connect the network/communication cable first before programming.

The maximum cable length between timers is 100 feet.

Connect each unit in series (do not form a loop) together from one communication port to the next communication port. It does not matter which one goes to the next one.

### 2510/2750/2815/2850/2900 Valves:

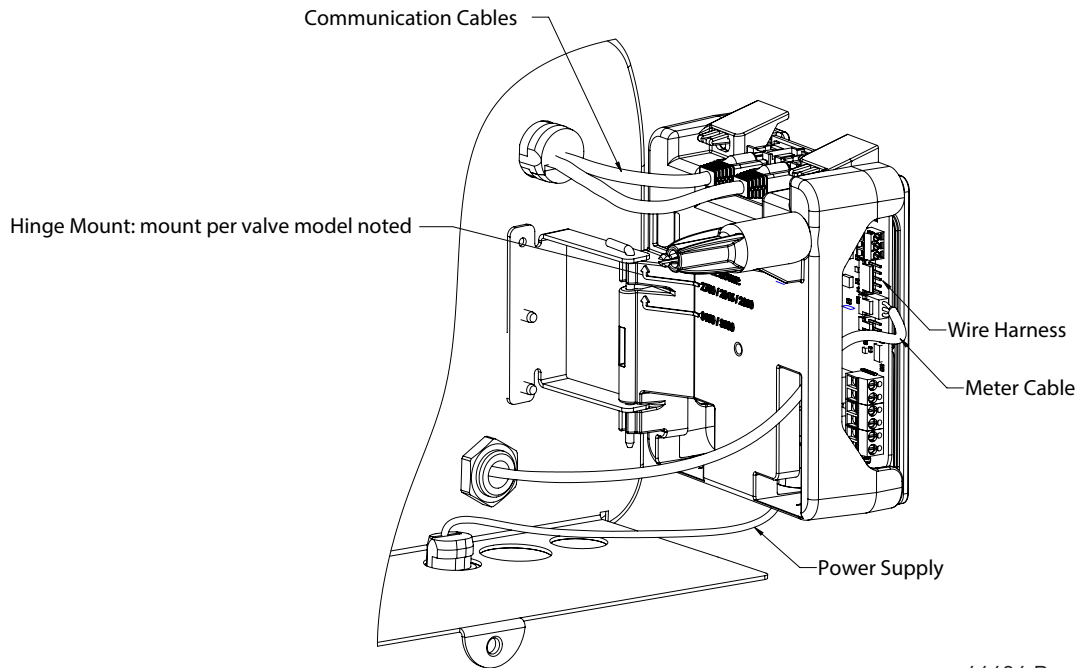

44404 Rev A

### 3150/3900 Valves:

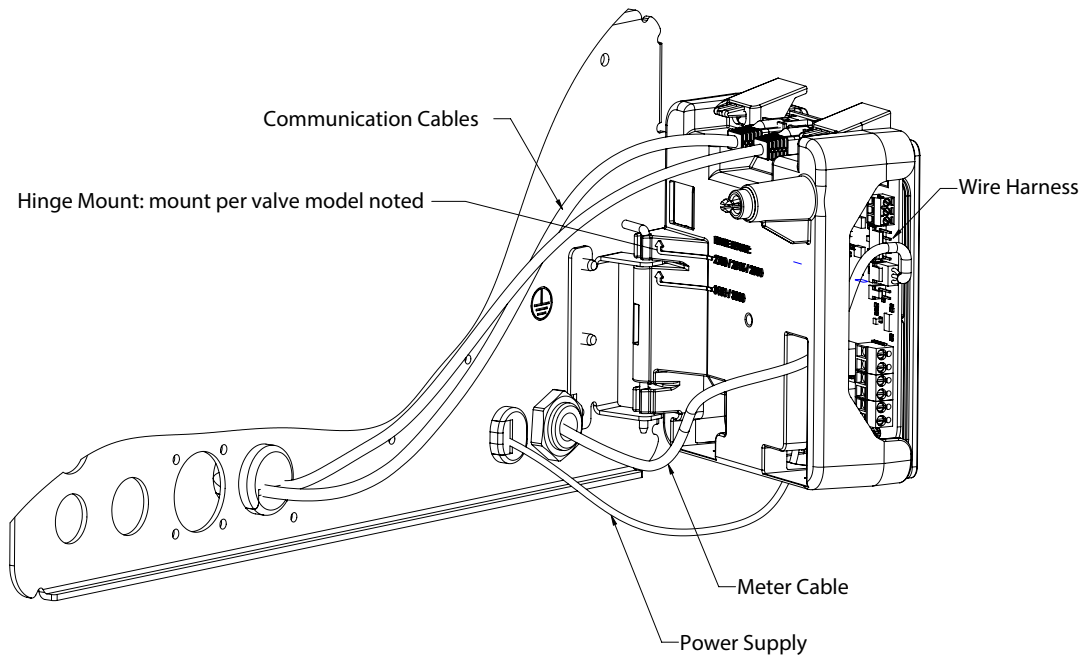

44403 Rev A

## ERROR CODES AND TROUBLESHOOTING

### Detected Errors

If a communication error is detected, an Error Screen will appear.

- All units In Service remain in the In Service position.
- All units in Standby go to In Service.
- Any unit in Regeneration when the error occurs completes Regeneration and goes to In Service.
- No units are allowed to start a Regeneration Cycle while the error condition exists, unless they are manually forced into Regeneration.
- When an error is corrected and the error no longer displays (it may take several seconds for all of the units in a system to stop displaying the error message), the system returns to normal operation.

**NOTE: During the error condition, the control continues to monitor the flow meter and update the volume remaining. Once the error condition is corrected, all units return to the operating status they were in prior to the error. Regeneration queue is rebuilt according to the normal system operation. Or, if more than one unit has been queued for regeneration, then the queue is rebuilt according to which one communicates first.**

Message Displayed	Cause For Error	Correction
Error Valve Count Mismatch	Number of NXT2 detected does not match selected system type in Master Programming	Push correct valve settings in Master Settings
Motor Stall No Changes Detected in the Optical Sensor for 6 Seconds	The motor is on but no encoder pulses are detected within a given duration while homing.	Check the P11 connection and trigger a manual regeneration.
Motor Run-On No CAM Switch Change Detected	The motor is on but no encoder pulses are detected or CAM Switches change state within a given duration.	Verify correct valve type is chosen. Trigger a manual regeneration.
Optical Sensor Undesired change detected by the Optical Sensor	The motor is off but additional encoder pulses are detected.	Trigger a manual regeneration.
Over-Current Motor Over-Current is Detected	Motor current exceeds thresholds.	Trigger a manual regeneration.
Flow Meter Error Continuous Flow Detected	Flow exceeded specified threshold for a specific duration.	Trigger a manual regeneration.
Error Send/Receive Failure	During a setting push, a packet was missing.	Reconnect communication cables and push setting in Master Settings.
Error System Type Mismatch on Network	The system type among connected units does not match.	Push correct system settings in Master Settings.
Microcontroller Error	Calibration or manufacturing test was not performed	Contact your Pentair representative.
100 Days Without Regen	100 Days have expired without a regeneration	Trigger a manual regeneration

}

**COMPLETE  
WATER**  
S O L U T I O N S



(855) 787-4200 [info@complete-water.com](mailto:info@complete-water.com)